

N₂O WASTEWATER SYSTEM



N₂O WASTEWATER SYSTEM USER MANUAL

UNISENSE ENVIRONMENT A/S

TABLE OF CONTENTS

1. WARRANTY AND LIABILITY	5
1.1. SENSOR HEADS	5
1.1.1. REPLACEMENT OF SENSOR HEADS	6
1.2. CALIBRATION KIT	6
1.3. CONTROLLER AND ACCESSORIES	6
2. SERVICE, ORDERING, AND CONTACT INFORMATION	7
3. OVERVIEW	8
3.1. APPLICATION	8
3.2. COMPONENTS	8
4. BACKGROUND	11
4.1. PRODUCTION OF NITROUS OXIDE IN WASTEWATER	11
4.1.1. TRIGGER CONDITIONS FOR NITROUS OXIDE FORMATION	12
5. PLACEMENT OF THE N ₂ O WASTEWATER SENSOR	13
6. GETTING STARTED	15
6.1. MOUNTING AND CONNECTING THE N ₂ O WASTEWATER SENSOR AND CONTROLLER	15
6.2. CALIBRATION OF THE SENSOR	16
6.3. NITROUS OXIDE EMISSION RATES	16
6.4. READING DATA FROM THE N ₂ O WASTEWATER CONTROLLER	17
7. N ₂ O WASTEWATER SENSOR	18
7.1. MOUNTING THE N ₂ O WASTEWATER SENSOR	18
7.2. CONNECTION AND PRE-POLARIZATION OF THE N ₂ O WASTEWATER SENSOR	18
7.3. THE CONSTRUCTION OF THE N ₂ O WASTEWATER SENSOR	19
7.4. CALIBRATION	20
7.5. AUTOZERO	22
7.6. REPLACEMENT OF AN N ₂ O WASTEWATER SENSOR HEAD	22
7.7. TEMPERATURE SENSOR	23
7.8. INTERFERENCES	23
8. N ₂ O WASTEWATER CONTROLLER	24
8.1. CONNECTIONS	25
9. THE CONTROLLER SCREEN	27
9.1. THE OVERVIEW WINDOW	27
9.2. N ₂ O EMISSION CALCULATION	28
10. N ₂ O-EMISSION OVERVIEW	30
10.1. MASS TRANSFER PARAMETER (K _L AN ₂ O)	30
11. STORAGE AND MAINTENANCE	32
11.1. THE N ₂ O WASTEWATER SENSOR	32
11.2. THE N ₂ O WASTEWATER CONTROLLER	33
12. REFERENCES	34
13. TROUBLESHOOTING	35
13.1. SENSOR	35

14. APPENDIX	38
14.1. APPENDIX 1: SPECIFICATIONS	38
14.2. APPENDIX 2: TWO-POINT CALIBRATION	40
14.3. APPENDIX 3: CALIBRATION FOR STANDARD, MEDIUM AND HIGH RANGE SENSOR HEADS	42
14.4. APPENDIX 4: CORRECTING N ₂ O SENSOR TEMPERATURE OFFSET ON LONG CABLES	43
14.5. APPENDIX 5: ADVANCED TEMPERATURE COMPENSATION	44
14.6. APPENDIX 6: CONNECTION CHART	45
14.7. APPENDIX 7: CHANGING THE N ₂ O WASTEWATER SENSOR HEAD	46
14.8. APPENDIX 8: FORMULAS FOR CALCULATING EMISSIONS	47
14.9. APPENDIX 9: CHANGING THE ANALOGUE SIGNAL RANGE	49
14.10. APPENDIX 10: ZERO CALIBRATION	50
14.11. APPENDIX 11: USB DOWNLOAD OF DATA AND PCA3000 SOFTWARE	51
14.12. APPENDIX 12: MODBUS/TCP CONNECTION AND SETUP GUIDE	55

1. WARRANTY AND LIABILITY

1.1. SENSOR HEADS

Sensor heads are considered consumables and Unisense Environment guarantees that they will work according to the specifications for 4 months from the date of receipt.

THE LIMITED SENSOR WARRANTY SHALL UNDER NO CIRCUMSTANCES INCLUDE PHYSICAL DAMAGE TO THE TIP OF THE SENSOR.

The limited sensor warranty will terminate immediately if the sensors are not examined and tested immediately upon receipt. Unisense Environment will replace defective sensors if they have been tested according to the instructions in the manual within 14 days of receipt of the sensor(s).

The Customer shall notify Unisense Environment of any defect that occurs during the Warranty Period no later than five (5) business days after discovery of the defect, or after the defect should have been discovered by the Customer. The limited sensor warranty does not apply to defects that are discovered after the Warranty Period or that are not reported to Unisense Environment within five (5) business days of being or should have been discovered.

If a defect arises and the Customer submits a valid claim to Unisense Environment in accordance with the section above, Unisense Environment will replace the sensor free of charge or refund to the Customer any amounts paid to Unisense Environment for the sensor. The replacement of the sensor or the refund of amounts shall be the Customer's sole remedy in case of a defect in a sensor.

For replacement of a defective sensor the Customer must contact Unisense Environment for a return authorization and thereafter return the sensor to Unisense Environment for inspection in the original sensor box and packed in accordance with instructions given by Unisense Environment staff.

Under no circumstances may the sensors be used in human diagnostic or therapeutic procedures.

1.1.1. Replacement of Sensor Heads

Unisense Environment replaces Sensor heads that have been damaged during transportation provided that:

- The sensors were tested immediately upon receipt as specified in the General Terms of Sale and Delivery and the manual
- The sensors are returned to Unisense Environment for inspection within two weeks
- The sensors are packed correctly during the return shipment to Unisense Environment (contact sales@unisense.com for instructions).

A standard N₂O Wastewater Sensor Head is working correctly (at 21 degree Celsius=room temperature) if:

- The raw signal for zero nitrous oxide (in tap water or air) is below 3% after being mounted and turned on for >12 hours.
- If the slope after calibration is larger than ~15%
- It has a response time of <65 seconds

1.2. CALIBRATION KIT

The N₂O Calibration Kit is a consumable with a lifetime of 6 months as noted on the kit.

1.3. CONTROLLER AND ACCESSORIES

Controller and accessories are covered by a 1-year limited warranty.

2. SERVICE, ORDERING, AND CONTACT INFORMATION

If you wish to order additional products or if you encounter any problems and need scientific/technical assistance, please do not hesitate to contact our sales and support team. We strive to respond to your inquiry within one working day.

E-mail: sales@unisense.com

Unisense Environment A/S
Langdyssen 5
DK-8200 Aarhus N
Denmark

Tel: +45 8944 9500
Fax: +45 8944 9549

Further documentation and support is available on our website:
www.unisense-environment.com

Note: If you find errors in this manual or have suggestions for improvements, please do not hesitate to contact us.

3. OVERVIEW

3.1. APPLICATION

Unisense Environment's N₂O Wastewater Sensor is designed to measure nitrous oxide (N₂O) directly in the wastewater where it can monitor nitrous oxide concentrations online 24/7 as well as calculate nitrous oxide emissions. The main application is to measure in the liquid phase of an activated sludge process or other types of biological wastewater treatment.

Nitrous oxide is a natural intermediate in the biological removal of nitrogen, and the N₂O Wastewater System is an efficient tool for understanding the biological processes during the nitrogen removal process in a treatment plant.

Nitrous oxide is a greenhouse gas 273 times stronger than CO₂. Knowledge on N₂O formation can be used to control the removal of the wastewater's nitrogen in such a way that the nitrous oxide emission – and thereby the WWTP's carbon footprint – can be held at a minimum.

3.2. COMPONENTS

The N₂O Wastewater System is comprised of an N₂O Wastewater Controller and 1 or 2 N₂O Wastewater Sensors.

The N₂O Wastewater Controller is used to calibrate and temperature compensate the nitrous oxide measurements. It can also be used for calculating the nitrous oxide emission rate with input from the aeration system. Unisense Environment advises setting up emission calculations directly in the WWTP SCADA as it provides maximum flexibility in data handling.

By default the N₂O Wastewater Controller is delivered with a 4-20mA and Modbus/TCP output that can be connected directly to the WWTP's control system. Another option is to connect the sensor to the SCADA system via -DP interface.

Nitrous oxide measurements can furthermore be downloaded to a USB stick (USB 2.0) and be interpreted on a computer using the optional PCA3000 Evaluation Software.



N₂O Wastewater Controller

The N₂O Wastewater Sensor consists of 3 components: Sensor Body, Sensor Head, and Sensor Protection Tube (see below).



The three components of the N₂O Wastewater Sensor:
Sensor Body (1), Sensor Head (2) and Sensor Protection Tube (3)

The Sensor Body contains an amplifier, a temperature sensor and is delivered with a standard 5m cable that can be extended to a total length of 100 m. The Sensor Body and Protection Tube are made of robust, surface protected aluminium. The Sensor Protection Tube protects the Sensor Head which is an extremely sensitive, electro-chemical N₂O Sensor with a detection limit of <0.005 mg N₂O-N per litre. For detailed specifications see Appendix 1: Specifications.

The N₂O Wastewater Controller can be mounted at a relevant spot at the WWTP using Unisense Environment's Pipe Mount Kit and Weather Protection Canopy. Furthermore,

IMPORTANT:

Never leave the Sensor Body out in the open without a Sensor Head or black closure cap that it is shipped with. Alternatively cover well with e.g. a plastic bag. Water intrusion will damage electrical connections!

the sensor can be secured by using Unisense Environment's Chain Mount Kit, or other suitable equipment.



Left: Controller with Pipe Mount Kit and Weather Protection Canopy

Right: Sensor with Chain Mount Kit

By default, the Unisense N₂O Wastewater System consists of:

- N₂O Wastewater Sensor Body with
 - Temperature sensor
 - 5 m cable attached to sensor with chain mount
 - N₂O Signal amplifier
- N₂O Wastewater Sensor Protection Tube
- N₂O Wastewater Sensor Head
- N₂O Wastewater Controller (with 4–20 mA and Modbus TCP/IP & Serial)
- N₂O Calibration kit
- N₂O Sensor Removal Tool

Optional equipment:

- Extra cable (total length up to 100 m for each sensor)
- Pipe mount kit
- Weather protection canopy
- Chain mount kit
- Profibus-DP card
- Datalogger Software
- PCA3000 (for USB 2.0 data readout; requires a notebook or desktop PC with Win 7 or higher)

4. BACKGROUND

4.1. PRODUCTION OF NITROUS OXIDE IN WASTEWATER

Nitrous oxide is produced during the biological removal of nitrogen. It can be considered a sideproduct of bacterial metabolism that is produced in elevated amounts if process conditions are sub-optimal or the processes are out of balance. Below graphic shows an overview of the various routes of biological N_2O production.

Chemical formation is also described, but considered a minor factor in wastewater treatment. The amount of nitrous oxide that is produced and emitted to the atmosphere varies between WWTPs.

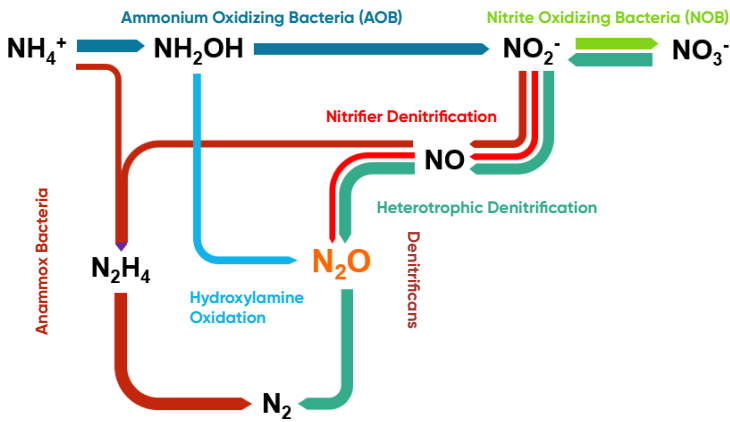

Microbial processes in wastewater that can produce nitrous oxide

Laboratory experiments and measurements in full-scale WWTPs show that nitrous oxide emission is high when one or more of the below conditions apply.

4.1.1. Trigger Conditions for Nitrous Oxide Formation

- **Low oxygen concentration during nitrification**

Typically below 0.5 mg/L

- **Low COD/N ratio for denitrification**

Typically below 3.5 to 4 (stoichiometric) or below 6.5 in the inlet

- **Shock loading of NH_4^+**

E.g. a reject water pulse or first flush during rain events

- **Nitrite (NO_2^-) accumulation during nitrification**

E.g. due to high NH_4^+ conversion rate

- **Oxygen availability during denitrification**

Typically above 0.05 mg/L

- **Short sludge age**

Complex COD is not used efficiently and low AOB amount.

- **Low temperatures**

Rates of the microbial processes are low

- **Change in temperatures**

E.g. in spring/summer: changes in bacterial population leading to imbalance

5. PLACEMENT OF THE N₂O WASTEWATER SENSOR

The recommended measuring point for the N₂O Wastewater Sensor is in the activated sludge process or alternative biological nitrogen removal process. More precise placement depends on the type of WWTP – e.g. whether the system has bottom aeration or surface aeration.

The sensor should be placed right below the water surface, fully submerged at all times.

IMPORTANT:

The sensor is sensitive to mechanical damage. Use proper mounting and placement to make sure it does not suffer e.g. from banging into a wall or similar.

Alternating processes: In an alternating WWTP, the wastewater is typically fed continuously to multiple, connected tanks. The oxic and anoxic periods occur in the same tank. Typically, one sensor would be placed in each tank.

Recirculation plants: In a recirculation plant, the aerobic nitrification tank is separated from the denitrification process. It is suggested to place one sensor in each of the 2 process tanks: one by the outlet of the anoxic zone and the other 1/3 into the aerated zone.

An example of sensor placement in a typical recirculation plant

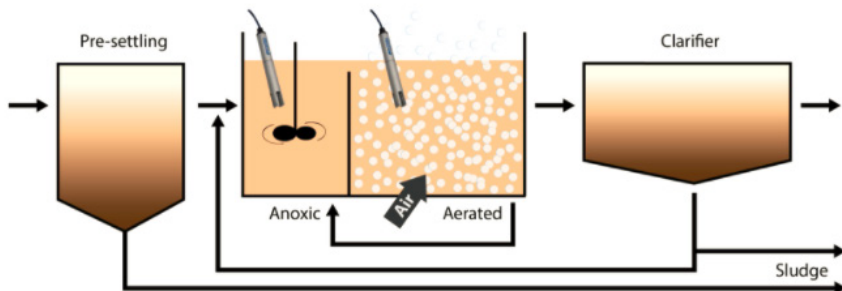

Bottom aeration: In a plant with bottom aeration in only parts of the tanks, the sensor should be placed about 1/3 downstream in the aeration area. If two sensors are available in the same tank, one could be placed before and one above the bottom aeration. The set of equations in **Appendix 8** can be used to calculate the emissions, ideally set up in the treatment plants SCADA system.



Cleaning of the N₂O Wastewater Sensor on top of the reject water tank
at VandCenterSyd, Odense, Denmark

Surface aeration: In plants with surface aeration, it would be appropriate to place the sensor right before the surface aeration rotor. If a second sensor is available, it can be placed in another part of the process that is not affected by the aeration. Calculation of emissions from surface aerated plants is possible, but it is not as simple as for bottom aeration. Contact Unisense Environment for further support.

Side stream processes: The reject water from sludge dewatering typically contains high concentrations of ammonium and a low COD-content. These conditions provide a high potential for N₂O formation. The nitrogen is primarily removed through anaerobic ammonium oxidation (Anammox process) also called the deammonification process. In reject water tanks, the wastewater is aerated with a low dissolved oxygen setpoint, so that about half of the ammonium is oxidized to nitrite and the other half is consumed through reaction with nitrite in the Anammox process. N₂O can be used as a proxy for nitrite, which is more difficult to measure in real time. In these plants, one sensor should be placed in each process water tank.

6. GETTING STARTED

6.1. MOUNTING AND CONNECTING THE N₂O WASTEWATER SENSOR AND CONTROLLER

1. Find the correct location for the N₂O Sensor and N₂O Wastewater Controller and mount the Controller safely, e.g. by using the Pipe Mounting Kit and Weather Protection Canopy or in a suitable cabinet. It is recommended to place the N₂O Wastewater Sensor in the wastewater using the Sensor Chain Mount to avoid strain on the cable. See **Section 7.1**.
2. The N₂O Wastewater Controller may be connected to the SCADA system of the WWTP. This will enable real time display of data in the SCADA system and logging of data together with other sensor data.
See **Appendix 6**: Connection Chart.
3. Remove the protective sticker from the controller screen.
4. Connect the controller to a power supply. The sensor measurements will be recorded in the controller as soon as the sensors are connected to a powered controller.
5. Connect 1 or 2 N₂O Wastewater Sensors to the controller. See **Appendix 7**: Installing the N₂O Wastewater Sensor Head, or the video found under the QR code on the right for a step by step guide to installation of a sensor head.
6. Let the sensors stabilize sitting in a bucket of tap water for 12 hours (e.g. overnight), until the signal is stable and the Raw Sensor Value (see section 9 "The Controller Screen") is below 2%.



IMPORTANT:

Never leave the Sensor Body out in the open without a Sensor Head or black closure cap that it is shipped with. Alternatively cover well with e.g. a plastic bag. Water intrusion will damage electrical connections!

7. Continue with calibration of the sensors.

6.2. CALIBRATION OF THE SENSOR

A two-point calibration is used to make the sensor operational. See **Appendix 2** or follow the QR code for a step-by-step guide of the calibration procedure.



In addition, note the following points:

- Calibration must take place at the same temperature as the wastewater which the sensor will be placed in. The calibration will be valid with minimal error for wastewater temperatures $\pm 3^{\circ}\text{C}$ of the calibrated temperature.
- The sensor is calibrated using Unisense Environment's N_2O calibration kit or similar equipment. The calibration temperature must be measured with a separate thermometer and this temperature must be entered manually into the controller.
- A sensor must be calibrated at least every 2 months or if the wastewater temperature changes more than 3°C .
- A graduated beaker is recommended to measure out the 4L of water precisely.
- It is recommended to use two insulated buckets for holding the calibration liquid in order to ensure a stable temperature. By having one bucket for the zero solution and one for the standard, one can also perform the calibration of two sensors in a row using only one standard ampule.
- Furthermore, a digital thermometer is recommended for calibration.

IMPORTANT:

The built-in temperature sensor is located high on the sensor body. As it is not submerged in water during calibration, the displayed concentration will not be precisely at the expected 0,94 mg/L.

6.3. NITROUS OXIDE EMISSION RATES

In case a connection to SCADA is not desired, the N_2O Wastewater Controller can calculate the N_2O emission rates based on input from one of the N_2O Sensors. This requires that details about the tank dimensions and the aeration are entered into the Controller:

1. Connect a 4-20 mA signal from an airflow meter to the controller and set Aeration to ON by following the connection chart. (See **Appendix 6: Connection Chart**)

2. Make sure the sensor is connected and measuring correctly.
3. Log into the controller box as Operator (code 1234).
4. In User Level, insert the following values:
 - The $k_L a_{20}$ value calculated for the average aeration rate (formula 1.4 in **Appendix 8**: Formulas for calculating Emissions).
 - **Aerated tank volume (m^3)**: Meaning the volume (area x water level) above the bottom aeration.
 - **Aeration field size (m^2)**: The total aeration field (m^2) is measured as the reactor surface where leaving air bubbles are detected visually by on-site inspection.

Alternatively, the equations in **Appendix 8** can be implemented in the WWTP's SCADA system. This is recommended for highest flexibility.

6.4. READING DATA FROM THE N_2O WASTEWATER CONTROLLER

Connection to a SCADA system: If the N_2O Wastewater Controller is connected to the SCADA system of the WWTP, the N_2O data are continuously delivered. The available data depends on the type of connection between controller and SCADA system:

4-20 mA analog output: The N_2O concentration will be transferred to the SCADA system

Modbus TCP/IP or Serial: The N_2O concentration, the temperature, and the sensor raw data (%-values) are transferred to the SCADA system

Profibus-DP card: The N_2O concentration, the temperature, and the sensor raw data (%-values) are transferred to the SCADA system

NOTE: The Modbus interface and the 4 - 20 mA analog output are always included. The Profibus-DP requires that an add-on Profibus-DP card is installed.

Internal logging of Data: The N_2O Wastewater Controller will always log data internally. A standard configuration with 2 sensors will store the data for about 1 year. When the capacity is reached, old data is overwritten by new data on a first in – first out basis. Data can be downloaded to a USB memory stick (USB 2.0) from the USB port on the controller for analysis with the PCA3000 Evaluation Software (license required).

7. N₂O WASTEWATER SENSOR

7.1. MOUNTING THE N₂O WASTEWATER SENSOR

The N₂O Wastewater System is intended to measure nitrous oxide outdoors directly in wastewater and in any kind of weather.

The N₂O Wastewater Sensor must be placed so that the entire metal body of the sensor is submerged in water. It is recommended to support the sensor's cable by mounting a chain along the cable and attaching it to the cable relief which comes with the sensor cable. The sensor must be placed in such a manner that it will not hit the tank wall or any other hard objects that could break the sensor. Possible changes in flow direction as well as the possibility of taking the sensor out of the water for calibration should be considered when placing it.



Solutions for mounting the sensor in wastewater.

IMPORTANT:

WARNING: Do NOT fix screws or any kind of metal directly onto the N₂O Wastewater Sensor as this will damage the surface protection of the aluminium by galvanic corrosion. Use only plastic material in contact with the sensor, such as the chain mount kit depicted above.

7.2. CONNECTION AND PRE-POLARIZATION OF THE N₂O WASTEWATER SENSOR

Install a sensor head, making sure that O-rings on the head and the aluminium tube are lubricated. See **Appendix 7: Installing the N₂O Wastewater Sensor Head** for details. You can also watch the instruction video by following this QR code. Note that it shows the process of exchanging a sensor head. For a first time installation you can start from 0:40



When the sensor is connected to the N₂O Wastewater Controller, the sensor is automatically pre-polarized for 30 minutes – The raw signal will rise steeply. After this time, you will see the transition from pre-polarizing to polarizing. The raw signal drops steeply first and slows down to reach a stable low level. Wait until the signal is stable below 2%. For new sensors, this can take up to 12 hours. During the pre-polarization and polarization, the sensor should be placed in a bucket of tap water.

If the signal does not stabilize or if it is too high, please go to the troubleshooting section in this manual or contact sales@unisense.com.

IMPORTANT:

When placing a sensor head on a sensor body, it needs to polarize before it can be calibrated and used. The raw signal (%) will rise steeply for 30min. Then the signal will fall slowly to a low value. This period can take different amounts of time, depending on the status of the sensor head:

1. If the sensor head was shortly taken of and replaced immediately, or the sensor cable is plugged out and back in: wait 30 min
2. If the sensor head was taken of for longer or is completely new: wait overnight

7.3. THE CONSTRUCTION OF THE N₂O WASTEWATER SENSOR

The Sensor Body contains the electronics and ensures that the sensor is automatically polarized as soon as it is connected to a powered N₂O Wastewater Controller. The Sensor Body also contains a temperature sensor that is placed in the middle of the Sensor Body. The Sensor Body and Protection Tube are made of robust, surface protected aluminium.



The three components of the N₂O Wastewater Sensor:
Sensor Body (1), Sensor Head (2) and Sensor Protection Tube (3)

The Sensor Head is a Clark-type Sensor with an internal reference, a cathode, a guard cathode and a front oxygen trap with reducing medium. It removes oxygen so that this does not interfere with the nitrous oxide measurements. When the Sensor Head is connected to the Sensor Body, the cathode and the guard cathode in the Sensor Head are polarized against the internal reference. This depletion of oxygen from the electrolyte starts when the sensor head is connected but takes a while to be reduced to a

stable background level. Therefore, the signal for zero nitrous oxide will be decreasing over the first hours after a sensor head is connected, and it is recommended to leave a newly connected Sensor Head to polarize overnight before calibration is performed.

Nitrous oxide enters the sensor through a silicone rubber membrane in the center of the 0.5 mm diameter glass sensor tip. Inside the sensor, nitrous oxide is reduced to N₂ which generates an electrical current. This is the sensor signal which is sent to the Controller for processing.

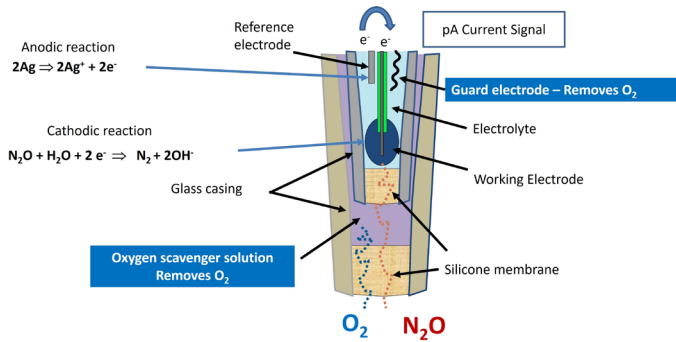

View of the sensor tip showing the measurement principle of the N₂O sensor

7.4. CALIBRATION

Calibration of the sensors can be done using the N₂O calibration kit or similar equipment. It should be performed at least every 2 months and also if the process temperature deviates by more than 3°C from the process temperature for more than a few days. Re-calibration is not recommended in case of short term temperature drops e.g. due to heavy rain.



The N₂O calibration kit is used for a 2-point calibration of the N₂O Wastewater Sensor. It contains enough standard solution for 3 calibrations.

See **Appendix 2: Two-point Calibration** for an illustrated guide to a 2-point calibration. For high range sensor heads, note the modifications described in **Appendix 3**.

Alternatively, have a look at this video guide:



A **graduated beaker** is recommended to measure 4L of water precisely. It is recommended to use **two insulated buckets** for holding the calibration liquid in order to ensure a stable temperature. By having one bucket for the zero solution and one for the standard, one can also perform the calibration of two sensors in a row using only one standard ampule. Furthermore, a **digital thermometer** is recommended for calibration.

The N₂O sensors respond linearly to nitrous oxide within their dedicated working range. Therefore, only a two-point calibration is needed. This is done by exposing the sensor to two concentrations of N₂O, zero, and one known concentration of N₂O. Tap water is used for the zero and the Unisense Environment Calibration Kit will give 0.94 mg N₂O-N/L, which is suitable for a Standard Range N₂O Sensor Head.

The sensor signal for N₂O is dependent on temperature. Therefore, the calibration should be performed at a temperature close to the measurement temperature. By default, the concentration value is compensated for a temperature ± 3 °C from the calibration temperature. An advanced temperature compensation can be used to increase this range. However, this is connected with significantly more labor than a usual calibration. See **Appendix 5: Advanced Temperature Compensation** for a description.

IMPORTANT:

WARNING: Do not place the Standard Sensor in a nitrous oxide concentration of more than 1.5 mg N₂O-N/L, as this will damage the sensor. The recommended calibration concentrations for non-standard N₂O Wastewater Sensors can be found in **Appendix 1**.

Unisense Environment offers a standard N₂O Wastewater Sensor and a High Temperature N₂O Wastewater Sensor. The sensors are available with:

- Standard Range (0-1.5 mg N₂O-N/L)
- Medium Range (0 – 9 mg N₂O-N/L)
- High Range (0 – 110 mg N₂O-N/L).

The standard N₂O Wastewater Sensors are designed to operate at temperatures between 0-27°C. The High Temperature N₂O Wastewater Sensor are designed to operate at temperatures between 27-40°C.

The N₂O Wastewater Sensors must never be exposed to N₂O concentrations above their working range as this will destroy the sensor. When using high range sensors on a 4-20 mA connection, the output ranges must be changed on the controller.

See **Appendix 9**: Changing Analogue Signal output (high range sensors) for details.

See **Appendix 3** for details on calibrating the alternative sensor heads.

Calibration logbook: This is available through the Device Menu and here all calibrations are saved with the zero-point and slope. The logbook can be used to monitor a sensor's performance over time. An old sensor will have a higher calibration slope than a brand new sensor.

Target values for calibration (standard range head, at room temperature):

Slope: 15-150%

Zero value: >-0,5

7.5. AUTOZERO

The measuring range of the sensor is extended into the negative, giving a maximum sensitivity at very low concentrations. If the sensor reads steady values between 0.00 and -0.05 N₂O-N mg/L for 15 min, the Autozero feature will set this as new baseline. If the values are continuously lower than -0.05, Autozero will raise an alarm indicating the need to perform a new 2-point calibration. Autozero is standard on all controller boxes after 1 October 2023. If negative values occur in older controller, a zero-point calibration should be done (See **Appendix 10**: Zero Calibration).

7.6. REPLACEMENT OF AN N₂O WASTEWATER SENSOR HEAD

Unisense Environment guarantees a lifetime of 4 months for the Sensor Head. However, the typical lifetime of the Sensor Head is half a year. For obtaining continuous data series, we recommend replacing the Sensor Head every 6 months.

IMPORTANT:

Never leave the Sensor Body out in the open without a Sensor Head or black closure cap that it is shipped with. Alternatively cover well with e.g. a plastic bag. Water intrusion will damage electrical connections!

Sensor heads cannot be stored, therefore they are made to order. Prescheduled shipment of sensor heads can be arranged with every order.

See **Appendix 7**: Installing the N₂O Wastewater Sensor Head for details on how to exchange a Sensor Head.

7.7. TEMPERATURE SENSOR

The measurement of the N₂O concentrations is temperature-dependent, and the N₂O concentration measurements are, therefore, temperature corrected. The N₂O Waste-water Sensor has a built-in temperature sensor that is placed in the middle of the Sensor Body.

As the temperature sensor is placed inside the aluminium housing, it responds slowly to changes outside the sensor body. The temperature sensor is factory calibrated and usually does not need further calibration. Should a difference in temperature measured by the sensor be detected when compared to a calibrated thermometer (e.g. in the process), a temperature offset can be set up as explained in **Appendix 4: Correction Temperature Offset Long Cables**.

During nitrous oxide measurements, it is important that the entire sensor (both the Sensor Head and the Sensor Body) is completely submerged in the water. Only the black top of the sensor may be visible above the water.

For further information about the temperature compensation, see **Appendix 5: Advanced Temperature Compensation**.



The temperature sensor is placed approximately in the middle of the sensor body.

7.8. INTERFERENCES

Avoid exposing the sensor to high concentrations of Hydrogen Sulfide (H₂S), as this can influence the sensitivity of the sensor. Nitric Oxide (NO) can also interfere with the sensor's signal, but concentrations high enough typically only occur in special cases during research experiments. If you suspect the sensor is broken, repeat the calibration and read **Section 13: Troubleshooting**.

8. N₂O WASTEWATER CONTROLLER

The N₂O Wastewater Controller can be installed outside next to the wastewater treatment process. When mounted outdoors, the N₂O Wastewater Controller must be protected to be operable in rain and sun, for example by the Weather Protection canopy. The Pipe Mounting Kit makes mounting easy for example on the rails of a boardwalk. Alternatively it can be mounted in a cabinet.



Mounting of the N₂O Wastewater Controller
using the Pipe mounting kit and Weather protection canopy

Data from the sensors will always be logged on the controller (for two sensors data storage for app. 1 year is available) but may also be sent directly to a SCADA system. The available protocols are 4-20 mA analog output, Modbus TCP or Serial, and optionally Profibus-DP. See **Section 6: Getting Started** and **Appendix 1: Specifications** for details. Data stored on the Controller may be downloaded to a USB memory stick (USB 2.0) for analysis on a PC with the PCA3000 software (license required).

The N₂O emission rates may be calculated on the Controller if the aeration rate is delivered via a 4-20 mA input. Unisense Environment recommends setting up emission

calculations in the SCADA system, using the calculations described in **Appendix 8:** Formulas for calculating Emissions.

NOTE:

For further information please see the N₂O Wastewater Controller Manual available at www.unisense-environment.com.

8.1. CONNECTIONS

In **Appendix 6:** Connection Chart you can see the detailed overview of the controller's connectivity options. The most frequently used are described below.

Power supply: The N₂O Wastewater Controller must be connected to a power supply (AC 110 to 240 V ± 10/15 %, 48 to 63 Hz). The cable for the power supply is on the left-hand side of the controller.

Sensor Connections: The N₂O Wastewater Sensors are connected through the controller's sensor channels that are located on the left-side top row (see photo below). The plug for sensor 1 is to the left and the plug for sensor 2 is to the right. Sensor plugs must be plugged in and then screwed tight.



Back view of the N₂O Wastewater Controller showing connections.

Output (4-20 mA): The nitrous oxide measurements and nitrous oxide emission rates can be sent directly from the controller to the SCADA system with 4-20 mA outputs. In the default settings, 4 mA corresponds to 0 mg N₂O-N/L and 20 mA corresponds to 2 mg N₂O-N/L. When using high range sensor heads, consult **Appendix 9:** Changing Analogue Signal output (high range sensors) for alternative settings.

I/O-connection (only needed if emission calculated on controller): Here it is possible to

connect an ON/OFF relay input from the SCADA system, so that the aeration measurements and emission calculations are turned on and off. If the aeration measurements should be constantly turned on, it is possible to create a shorting between 12 and 13 or between 14 and 15 in the controller's connection channels.

Profibus-DP: As an alternative to the 4-20 mA outputs, it is possible to have a Profibus-DP card installed. If your SCADA system functions as Master for external equipment, it is possible to install a Profibus-DP card in the controller, so that it becomes a part of the Profibus network. Thus, the controller's data can be read by the SCADA system together with data from all the other instruments.

To actively communicate between the Profibus-DP card in the controller and the master, you need to use a GSD-file (Device base data). It comes with 3 GSD-files which shall be used depending on whether 1 or 2 sensors are connected, and if only 1, whether it is connected to channel 1 or 2.

Contact sales@unisense.com to receive the GSD files by email or find them online at unisense-environment.com/software-download.

The typical GSD-configuration when using two sensors is:

- Temperature Sensor 1 "Analog/Analoginp./Temp 1"
- Temperature Sensor 2 "Analog/Analoginp./Temp 2"
- "imer/Remain run time Cal-Timer 1" Remain Time to calibration sensor 1
- "imer/Remain run time Cal-Timer 2" Remain Time to calibration sensor 2
- N₂O Conc. Sensor 1 with AutoZero "Analog/Math/Result Math 14"
- N₂O Conc. Sensor 2 with AutoZero "Analog/Math/Result Math 16"
- N₂O Conc. Sensor 1 "Analog/Math/Result Math 1" No Autozero
- N₂O Conc. Sensor 2 "Analog/Math/Result Math 2" No Autozero
- N₂O Emission Sensor 1 "Analog/Math/Result Math 3"
- N₂O Emission Sensor 2 "Analog/Math/Result Math 4"

NOTE:

A Profibus-DP card can be retrofitted and we are happy to assist. Contact sales@unisense.com for further information

Modbus TCP: Modbus TCP can be used as an alternative communication protocol. See **Appendix 12:** Modbus/TCP Connection and setup guide for a description. Note that the Modbus floats are read as 2 x 16 bits and also note the default and fixed port and unit IDs.

Installation guides for Modbus and Profibus are available online at : unisense-environment.com/software-download.

9. THE CONTROLLER SCREEN

9.1. THE OVERVIEW WINDOW

The screen on the N₂O Wastewater Controller screen is a touchscreen that allows navigation and interaction.

The N₂O Sensor Overview window (see figure below) is displayed when the controller is turned on. This window is split into two, the left side shows the signals from the sensor connected on channel 1 and the right side shows the signals from the sensor connected on channel 2. The bottom bar is permanent and is shown in all displays.

N₂O Sensor Overview: Signals for sensors connected to channel 1 and channel 2 are shown in separate columns. Raw sensor value in % can be used for troubleshooting and to see if a sensor head is behaving normally.

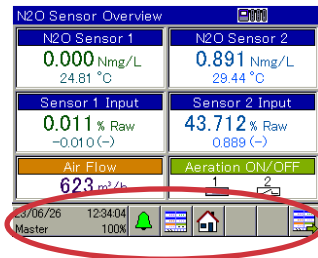

The N₂O Wastewater Controller's overview window for N₂O Wastewater sensors and airflow

Time and date: The time and date are shown in the lower-left corner. The percentage value in this field indicates the amount of available memory for recording data. When the memory is full, the oldest data will be overwritten (first in, first out principle).

To set the date, press the time and date field to open the Device menu and log in as 'Operator' using code 1234. Press the time and date field again to open the /Device Menu, press /Parameterization and then /Date and Time. Enter the correct time and date.

Bell: Shows possible alarms

Display icons and Home: Help navigate through the display windows.



N₂O Sensor 1/N₂O Sensor 2: These show the calibrated nitrous oxide concentration in mg N₂O-N/L, based on the latest calibration done. The sensor temperature measure-

ments are also shown in the 'N₂O Sensor 1/N₂O Sensor 2' fields.

The raw signal from the sensors is given as percentage of the full measurement range. For a standard N₂O Wastewater Sensor, a measurement of 1.5 mg N₂O-N/L will result in a raw signal of about 20-50%, depending on the specific sensor and temperature.

NOTE:

The value below the raw value shows the concentration without Autozero offset.

Airflow (m³/h): The Airflow can be shown here if the controller receives input from an airflow meter. See **Appendix 6: Connection Chart** on how to get the airflow data into the controller.

Aeration ON/OFF: This indicates if the N₂O emission is being calculated by the N₂O Wastewater Controller (see N₂O Emission Calculation below).



The boxes indicate whether the aeration is ON for the N₂O Wastewater Sensor 1

9.2. N₂O EMISSION CALCULATION

Unisense Environment recommends setting up the calculations directly in the WWTP's SCADA System for maximum flexibility, accuracy and convenience. The basis for the nitrous oxide emission calculations can be found in **Appendix 8: Formulas for calculating Emissions**.

The N₂O Wastewater Controller can also calculate and show the nitrous oxide emission rates in real-time based on one input of aeration rate.

The controller's N₂O emission calculations can be used in WWTPs with bottom aeration. Scientific studies have shown that the N₂O Wastewater Controller's nitrous oxide emission calculations based on nitrous oxide concentration measurements are consistent with off-gas measurements (See for example Baresel et al., 2016 and validation by Baeten et al., 2020).

It is also possible to calculate the nitrous oxide emission in wastewater without aeration, for example during denitrification, by programming the formula from **Appendix 8** into the plants SCADA system.

For WWTPs with surface aeration, a collection of formulas is available to provide an approximation. Contact sales@unisense.com for more details.

For the N₂O Wastewater Controller to calculate N₂O emission rates, continuous data for N₂O concentration, water temperature, and aeration rate in the tank are needed. Furthermore, these static parameters must be entered into the Controller: the tank's k_La-value, the aeration area, and the height of the water column above the diffusers.

One aeration rate can be directly fed into the Controller from an airflow meter or from the plant SCADA system through a 4–20 mA input (see **Appendix 6**: Connection Chart for installation). If two sensors are placed in two tanks with identical aeration rates, the aeration input to the Controller may be used for N₂O emission calculations in both tanks.

To activate the N₂O emission calculations for a given channel, two contact points in the Base Unit screw terminal block must be shortcircuited (see Connection Chart in Appendix 6: Connection Chart). To activate calculations on channel 1, connect points 12 and 13. To activate calculations on channel 2, connect points 14 and 15. The k_La-value of the plant, the area and the volume of aeration channels must be entered into the controller in the User Level – see **Section 10.1**: Mass Transfer Parameter (k_LaN₂O) for further information.

If sensor 1 and sensor 2 are placed in wastewater tanks with different aeration rates, it is possible to determine the nitrous oxide emission for both sensors by programming the emission formula directly into the WWTP SCADA system (**Appendix 8**: Formulas for calculating Emissions).

Contact sales@unisense.com for further information and support with emission calculations.

10. N₂O-EMISSION OVERVIEW

The nitrous oxide emission is displayed in the Emission Overview window.

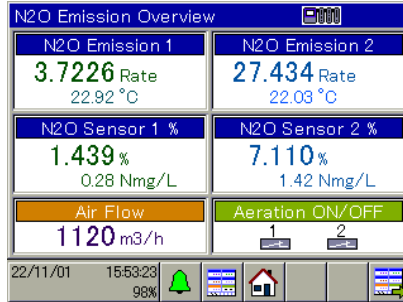

N₂O Emission 1/N₂O Emission 2: Here the nitrous oxide emission rates are given in g per aerated water volume per day (g N₂O-N m⁻³ d⁻¹) based on the nitrous oxide concentration measurements from the N₂O Wastewater Sensor, the sensors temperature measurements, and the air flow, as well as various inputs in User Level (see above). The temperature measurement that is used for the calculation is found in the display right below the N₂O emission rate.

N₂O Sensor 1%/N₂O Sensor 2%: Shows the raw value of the N₂O signal in percent of the Sensor Body's maximum signal.

Aeration ON/OFF: Indicates if the aeration is on or off. The aeration symbol must be on (dark box) in order for the N₂O Wastewater Controller to calculate the nitrous oxide emission.

Emission calculation can be turned ON in the following way as shown in the N₂O Emission Calculation section above.

It is possible to turn the emission calculation ON and OFF centrally from the SCADA system by connecting an ON/OFF relay into the Controller.

Air Flow: Here the air flow measurement (m³/h) is shown if an airflow meter is connected to the controller using a 4-20 mA connection (See **Appendix 6: Connection Chart**). Scaling is from 4 mA = 0 m³/h to 20 mA = 10,000 m³/h

10.1. MASS TRANSFER PARAMETER (K_LAN₂O)

The mass transfer parameter for nitrous oxide indicates the time it takes for the nitrous

oxide to be transferred from water to air. The mass transfer rate depends, among other things, on the aeration rate, the temperature, and water height above the diffusers in the bottom aeration setup.

To be able to calculate the nitrous oxide emission the controller must have the following inputs:

- $k_L a$ value at 20°C and at the average aeration rate.
- The volume (m³) of the aerated part of the WWTP.

For bottom aeration it is the water volume above the aeration fields.

- The area (m²) of the aerated part of the WWTP, i.e. only the area where the actual aeration takes place.

See **Appendix 8**: Formulas for calculating Emissions.

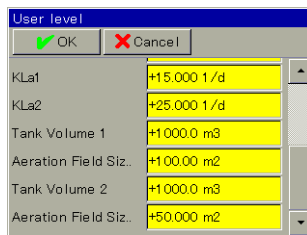

Parameter	Value
KLa1	+15.000 1/d
KLa2	+25.000 1/d
Tank Volume 1	+1000.0 m3
Aeration Field Siz.	+100.00 m2
Tank Volume 2	+1000.0 m3
Aeration Field Siz.	+50.000 m2

The values for the nitrous oxide emission rate calculations are entered under User Level

The values are entered as follows:

1. Log in as Operator (code 1234)
2. Go to 'User Level'
3. Calculate the $k_L a$ value at 20°C and the average aeration rate using formula 1.1. and 1.3 from **Appendix 8**: Formulas for calculating Emissions. Enter the value in KLa1 for the N₂O Wastewater Sensor connected to channel 1 and KLa2 for the N₂O Wastewater Sensor connected to channel 2.
4. Enter the volume in m³ (area x water level) above the bottom aeration (the area outside the bottom aeration should not be included)
5. Enter the area in m² for the bottom aeration (the area outside the bottom aeration should not be included).

11. STORAGE AND MAINTENANCE

11.1. THE N₂O WASTEWATER SENSOR

When the sensor is not used, it should be stored safely in the protection box it is delivered in. However, long-term storage (more than 2 months) of the sensor head is not recommended.

Once the sensor has been in contact with wastewater, it should not be left to dry, to avoid biofilm drying up on the tip. If it should leave the wastewater and be used again at a later stage, store it with the tip in a bucket of water.

Handling: The N₂O Sensor Head is made of glass and is therefore sensitive to mechanical force. When handling the sensor, e.g. while taking it out of the wastewater for calibration or during installation, make sure to avoid any impact (e.g. knocking on the railing or the side of the calibration bucket) which may damage the instrument.

Cleaning of glass tip: Being placed in wastewater, biofilm can develop on the N₂O Sensor Housing and the N₂O Sensor Head. From years of practical experience, it is known that the presence of biofilm on the sensor head does not interfere with measurements. This is because the outer sensor tip will stay free from biofilm due to its pointy geometry. Therefore, manual cleaning of the glass electrode is almost never necessary. If biofilm does develop on the outer tip of the sensor, it should be removed with running water and/or gentle wiping with soft tissue. Always wipe away from the tip!

External Cleaning: Before re-calibrating the sensor, the bulk of biofilm accumulated on the Sensor Housing (if present) and any larger objects (rags, hairs etc.) should be removed. This is done manually, by carefully rubbing the surface of the housing with a soft brush or sponge - Making sure to not touch the sensor tip in the process. Cleaning should be assisted by rinsing with water.

While this cleaning procedure may not remove all biofilm present, it will suffice to ensure a stable calibration.

If ragging is a constant issue at the site, removal of debris might be necessary more often to ensure that the tip of the sensor is exposed to the bulk liquid.



The debris on the left picture should be removed, while the tip of the right sensor does not need to be cleaned before calibration. If the outer tip is fouled, clean only with running water and soft tissue, always wiping away from the tip.

11.2. THE N₂O WASTEWATER CONTROLLER

The controller must be protected against sun, wind and weather. Cleaning is done using tap water, mild soap, and a very soft brush.

12. REFERENCES

Baeten, J. E., Loosdrecht, M. C. M. Van, & Volcke, E. I. P. (2020). **When and why do gradients of the gas phase composition and pressure affect liquid-gas transfer?** *Water Research*, 178, 115844.

<https://doi.org/10.1016/j.watres.2020.115844>

Baresel, C., Andersson, S., Yang, J., & Andersen, M. H. (2016). **Comparison of nitrous oxide (N₂O) emissions calculations at a Swedish wastewater treatment plant based on water concentrations versus off-gas concentrations.** *Advances in Climate Change Research*, 7(3), 185–191.

<https://doi.org/10.1016/j.accre.2016.09.001>

13. TROUBLESHOOTING

13.1. SENSOR

When erratic behaviour is observed, place the sensor in tap water and follow the guidelines below. When in doubt, perform a new calibration. For sensor troubleshooting, always read the Raw Sensor Value in %, as this is independent of the last calibration.

IMPORTANT:

When placing a sensor head on a sensor body, it needs to polarize before it can be calibrated and used. The raw signal (%) will rise steeply for 30min. Then the signal will fall slowly to a low value. This period can take different amounts of time, depending on the status of the sensor head:

1. If the sensor head was shortly taken of and replaced immediately, or the sensor cable is plugged out and back in: wait 30 min
2. If the sensor head was taken of for longer or is completely new: wait overnight

Problem	Possible cause(s)	Solution attempt(s)
Raw Sensor Values above 2% in air or tap water.	Air bubble in the tip of the N ₂ O Wastewater Sensor.	<p>1. Remove the air bubble by lifting the sensor above your head (tip pointing up) and give it a big "shake" downwards - as you would with an old-fashioned mercury thermometer. Be careful not to break the sensor. Click here for instruction video.</p> <p>2. If the raw Sensor Value remains high, it may be due to very small air bubbles in the tip. These may be removed from the tip by placing it in degassed water. For this, boil a few liters of water for about 10 min. Let the water cool down to ambient temperature without stirring and place the sensor in this water for 1 hour.</p>

<p>Raw Sensor Value is constantly high (99-100%) or low. No reaction to N₂O.</p>	<ol style="list-style-type: none"> 1. The tip of the sensor or the sensor membrane is broken, likely due to physical damage. 2. Water has entered between the sensor body and sensor head, often due to mishandling. 3. Controller is faulty (e.g. loose wiring) 	<ol style="list-style-type: none"> 1. Replace sensor head. If in doubt return faulty one to Unisense for inspection. 2. Test if problem is with sensor body or controller by switching around two sensor body cables. Wait 30 min for the polarization procedure to take place. If applicable, return sensor body to Unisense for repair. 3. If possible, check if all wiring in controller is correct and not loose. If no result, return controller to Unisense for repair.
<p>N₂O concentration value (mg N₂O-N/L) fluctuates strongly when sensor is in tap water</p>	<p>The previous calibration is faulty.</p>	<p>Input a manual calibration by going to the menu: /Calibrate / N₂O Sensor # /Calibration values Enter a zero point of 0 and a slope of 30%. This should stabilize the value and you can perform a regular calibration.</p>
<p>Baseline drift: baseline at < -0.01 or > 0.01 mg/L. (Mind that negative numbers are logged in SCADA as zeros, so a baseline drift towards negative values can be identified in SCADA by measuring zeros for a long time, not by negative numbers.)</p>	<ol style="list-style-type: none"> 1. The sensor head is old 2. The wastewater temperature has changed more than 3°C since the last calibration. 	<ol style="list-style-type: none"> 1. Exchange the sensor head 2. Perform a two-point calibration.
<p>Increase of baseline over time</p>	<ol style="list-style-type: none"> 1. Sensor head is old or has been exposed to elevated N₂O over long time 2. Sensor has been used at high temperature (<35°C) 	<ol style="list-style-type: none"> 1. Replace sensor head 2. Consider a High Temperature version of the sensor head.

Slow response time: e.g. after 10 min waiting the measurement value is still increasing in the high concentration calibration liquid.	<ol style="list-style-type: none"> 1. Sensor head is old. 2. Presence of an air bubble in the sensor tip. 	<ol style="list-style-type: none"> 1. Replace sensor head 2. Perform air bubble procedure from top of this list
High slope after calibration (> 75%).	<ol style="list-style-type: none"> 1. Faulty calibration. 2. Sensor head is old. 	<ol style="list-style-type: none"> 1. Perform another two-point calibration. 2. Replace sensor head
Sensor Body and Sensor Housing have started to corrode.	The corrosion protective layer on the aluminum sensor housing (the anodization) has deteriorated and/or the sensor is in direct contact with another metal which will cause galvanic corrosion.	Replace the corroded parts and make sure that the sensor is not in direct contact with any other metal when it is in water.
The N ₂ O Wastewater Sensor can be calibrated, but the calibrated nitrous oxide concentration does not appear in the overview window. The temperature value is fluctuating.	<ol style="list-style-type: none"> 1. There is a fault in the temperature sensor, located in the sensor body 	<ol style="list-style-type: none"> 1. Test if the problem is with the sensor body by switching it to the other channel on the controller. If issue can be located to sensor body, return it to Unisense for repair.
No Temperature reading is given on controller (---)	<ol style="list-style-type: none"> 1. There is a fault in the temperature sensor, located in the sensor body 	<ol style="list-style-type: none"> 1. Test if the problem is with the sensor body by switching it to the other channel on the controller. If issue can be located to sensor body, return it to Unisense for repair.
The touchpad reacts in an imprecise way	<ol style="list-style-type: none"> 1. The calibration of the touchpad is off. 	<ol style="list-style-type: none"> 1. Run a screen calibration by going to the menu: /Calibrate touchscreen and follow the prompts. This may need to be repeated several times.

If you experience other errors or problems and you need technical assistance, please contact us at sales@unisense.com (we strive to respond within one working day).

14. APPENDIX

14.1. APPENDIX 1: SPECIFICATIONS

N₂O Wastewater Controller	
Controller	TFT-touch screen controller
Box size	301.5 x 283.2 x 120.5mm, 3.2 kg
Housing	Surface-mounted case made of plastic (ABC) IP67
Mounting	Multiple holes for surface or pipe mounting - mounting plates and weather protection canopy available
Sensor inputs	2 x N ₂ O Wastewater Sensor with built-in temperature sensor
Other inputs	Optional: Airflow (0-10,000 m ³ /h) 4-20 mA Optional: 2 x Airflow ON/OFF (Binary input - potential-free contact)
Sensor output	2 x temperature compensated N ₂ O value (mg N ₂ O-N/L)
Sensor emission output	2 x Emission calculations (N ₂ O-N (mg/m ³ /d)) with standard fixed model parameters Optional: Dynamic input parameters
Other outputs	Internet, Modbus TCP Optional: 2 x N ₂ O Wastewater temperature sensor Optional: Profibus-DP Optional: USB 2.0 datalogging - software required
Electrical safety	According to EN 61010, part 1 overvoltage category III, pollution degree 2
Power supply	AC 110 to 240 V + 10/15 %; 48 to 63 Hz

N₂O Wastewater Sensor	
Size	Robust design in 44 mm aluminium alloy casing (6063-T6) and black POM acetyl copolymer
Response time	< 65 sec
Built-in temperature sensor	Yes, N ₂ O signal temperature compensated
Calibration	2-point calibration every two months
Guaranteed lifetime	4 months
Expected lifetime	>6 months

N ₂ O Sensor Head	Replaceable
Cable Length	5 meter standard Optional: Extension up to 100 m
Known relevant interferences	None

Sensor Heads - Measuring ranges and detection limits						
Type	Working Range			Detection Limit**		
	mg N ₂ O-N/L	µmol/L	ppm*	mg N ₂ O-N/L	µmol/L	ppm*
E-N ₂ O Head SR	0 - 1.5	0 - 53	0 - 2,160	0.005	0.18	7
E-N ₂ O Head MR	0 - 9	0 - 320	0 - 13,000	0.03	1.0	45
E-N ₂ O Head HR	0 - 110	0 - 3,900	0 - 160,000	0.4	14	575
E-N ₂ O Head HT SR	0 - 1.5	0 - 53	0 - 2160	0.005	0.18	7
E-N ₂ O Head HT MR	0 - 9	0 - 320	0 - 13,000	0.03	1.0	45
E-N ₂ O Head HT HR	0 - 110	0 - 3,900	0 - 160,000	0.4	14	575

Notes: *1 µmol/L N₂O = 40 ppm at 25°C. LR = Low Range. HR = High Range.**Indicative only, valid recent specifications found on

www.unisense-environment.com

Temperature:

The standard N₂O Wastewater Sensors are designed to operate at the given response time of 65 sec in a temperature range between 0-27°C. The High Temperature N₂O Wastewater Sensors are designed to operate at the given response time of 65 sec in a temperature range between 27-40°C.

At lower temperatures the sensors will respond slower.

14.2. APPENDIX 2: TWO-POINT CALIBRATION



Scan the QR code for calibration video guide



N₂O CALIBRATION KIT SUBSCRIPTION
 CONTACT SALES@UNISENSE.COM
WWW.UNISENSE-ENVIRONMENT.COM

N₂O Wastewater Sensor



Step by step calibration procedure



1



Follow these few steps to calibrate the N₂O Wastewater Sensor. We **recommend re-calibrating every second month**, or if the average wastewater temperature changes by more than 3 degrees Celsius.

2



After you have installed the N₂O Wastewater Sensor or replaced the sensor head, let the sensor **stabilize overnight**. This will give the best calibration result. We recommend that you leave the sensor in clean water to avoid cleaning, except if there is a risk of frost.

3



Fill a stable bucket with 4 liters (**NOTE: for MR and HR sensors, see manual**) of tap water. The tap water temperature should be close to that of the process water. Measure the tap water temperature* and place the sensor in the bucket. Let the sensor signal stabilize (min. 1 minute).
 *This temperature must be entered in step **10** below !

4

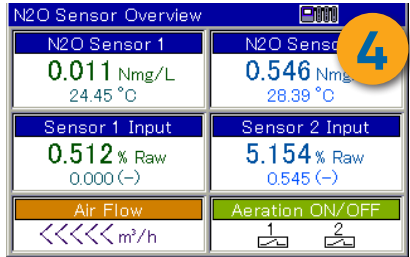

On the controller screen, check for a stable sensor signal. Press the grey button on the bottom left, reading Operator (Password: 1234) to access the **Device menu**.

Device menu

- Exit
- Logon/logoff
- Calibration
 - IN6 Air Flow
 - IN11 N2O Sensor 1
 - Two-point calibration

5

Follow the pathway to begin the calibration. Select **Two-point calibration** for N₂O Sensor 1 or 2 as depicted above.

Calibration step 1/2

6

When the signal is stable, press OK to open 'Reference input'. Press the blue number field, input 0 as 'value 1'. Then press OK.

7

Break the ampule's neck. Continue immediately to use the syringe and needle to slowly draw out **5 mL** of the liquid. Inject the stock solution to the tap water. Stir gently with the N₂O Sensor to dissolve the solution in the water. **IMPORTANT:** Inject the stock solution under water to avoid contact with air.

Calibration step 2/2

8

You will now see the reading increase. **IMPORTANT:** Press OK just after the signal has stabilized, as the signal will start to drop shortly after. Press the blue number field and enter the value 0.94. Press OK. Check that the zero point is close to 0 and that the Slope is between 15% and 150%.

Device menu

- Device menu
 - Exit
 - Logon/logoff
 - Calibration
 - User level
 - Configuration
 - Parameterization

9

Finally enter the **Device menu** again (check step **5**). Access the **User level** to set the temperature of the tap water from step **3**.

User level

CalTemp1	+19.500 °C
CalTemp2	+22.000 °C
A1	+19.686
A2	+0.0017
B1	+7.3549
B2	+0.0361

10

For the calibrated sensor, enter the water temperature of the tap water used for calibration and press **OK**. Well done! You have successfully calibrated the sensor. **We recommend that you calibrate again in two months.**

14.3. APPENDIX 3: CALIBRATION FOR STANDARD, MEDIUM AND HIGH RANGE SENSOR HEADS

Please follow this instruction to calibrate Unisense Environment Standard (SR), Medium (MR), and High range (HR) sensor heads. It should be used as an addition to the instructions given in **Appendix 2**. See **Appendix 1** for an overview of the available Sensor Heads and their concentration ranges.

The sensors react linearly to nitrous oxide within the measuring range. Therefore, a calibration point that is lower than the full working range yields a valid calibration. However, the concentrations used to calibrate sensors should be adjusted to reflect the working range. This is done by mixing different amounts of calibration liquid with different volumes of water. Refer to the following table for the exact concentrations of N₂O to be used in calibration and how to produce them. The table also applies for High Temperature (HT) Sensor Heads.

Product	Volume calibration liquid (mL)	Volume water to dissolve (L)	Resulting concentration N ₂ O (mg/L)
E-N ₂ O Head SR (also HT)	5	4	0.94
E-N ₂ O Head MR (also HT)	5	2	1.88
E-N ₂ O Head HR (also HT)	10*	0,5	15.04

*Using 2 calibration ampules

For general guidance on how to calibrate the sensors, please refer to **Appendix 2**. Make sure to type in the relevant resulting concentration on step 8 of the calibration guide.

NOTE:

Sensors must never be exposed to N₂O concentrations above the measuring range. This may damage the sensor.

For the Medium and High Range sensors, one should use a smaller vessel to hold the water and ensure that the tip is fully submerged in liquid. This can be achieved by using a measuring cylinder or other beaker. Note that the calibration is sensitive to changes in temperature of the calibration liquid, an effect that is enlarged the smaller the volume of water is. The sensor body is made of aluminum, which can cool down the liquid significantly. Therefore, it is advised to take the sensor directly out of the process water and to rinse it (if required) with water that is also at process temperature.

If there is a large difference between process temperature and ambient temperature,

it is advisable to use an insulated container to perform the calibration in. Make sure to measure the temperature in the calibration liquid right after performing the calibration and input this temperature under "user level" on the N₂O controller (Step 10 in **Appendix 2**).

14.4. APPENDIX 4: CORRECTING N₂O SENSOR TEMPERATURE OFFSET ON LONG CABLES

The N₂O Wastewater Sensor has an incorporated resistivity based temperature sensor (PT100; 3-wire). As longer N₂O Wastewater Sensor cables have a variable cable length, the resistivity of the PT100 sensor signal may have an offset, in some cases up to 4°C. If an offset is observed, it is important to correct this.

Below is a step-by-step guide on how to do this.

1. Compare the N₂O Wastewater Sensor temperature with other process sensors' temperature readings (in SCADA or on-site sensor systems). The N₂O Wastewater Sensor temperature is found in the main screen.
2. If a correction is needed, enter the menu system in the lower left corner and login as 'MASTER' with pin code '9200'.
3. Enter the 'Configuration' menu.
4. Enter the 'Analog Inputs' menu.
5. Find the Temperature input for sensor 1 or sensor 2 and enter the relevant menu.
6. Find the value called 'Offset' and press the yellow field. An input window will pop up.
7. Enter the positive or negative offset value that will correct the temperature to the true value.
8. Finally, press the 'OK' button and exit the menu.
9. Double check that the N₂O Wastewater Sensor is now showing the correct temperature.

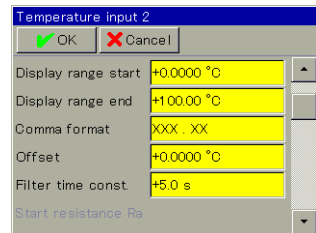
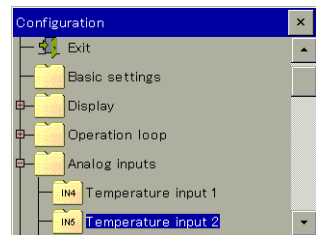
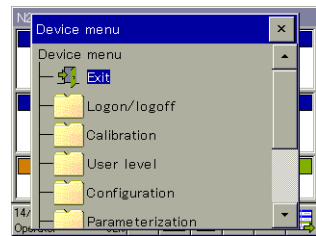
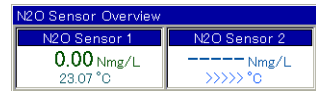

14.5. APPENDIX 5: ADVANCED TEMPERATURE COMPENSATION

Advanced N₂O Sensor Signal Temperature Compensation

A more advanced but also manually demanding temperature correction can be made by fitting a multipoint calibration to four parameters. The formula 2.2 has four sensor specific parameters, A1, A2, B1 & B2 that need to be readjusted to every new sensor by fitting to 6 - 10 point calibration with corresponding temperature values, e.g. by using solver in Excel or other fitting algorithms. This will enable a real-time and precise temperature compensated signal directly on the raw $S_{N_2O_{T_{Process}}}$ signal (in % mAinput range).

$$S_{N_2O_{Temp. Compensated}} \left(\frac{mg - N}{L} \right) = \frac{S_{N_2O_{T_{Process}}} - A1 * e^{A2 * T_{Process}}}{B1 * e^{B2 * T_{Process}}}$$

The A1, A2, B1 & B2 values are entered manually as 'User values' via the N₂O Wastewater Controller touch screen. Standard factory values are depicted below.

User level	
CalTemp1	+22.000 °C
CalTemp2	+22.000 °C
A1	+0.1192
A2	+0.0596
B1	+6.9689
B2	+0.0385

The A1, A2, B1 & B2 values are shared between the two N₂O Wastewater Sensors and the temperature corrected signal, $S_{N_2O_{Temp. Compensated}} \left(\frac{mg-N}{L} \right)$, is output as 'N₂O Sensor 1a' and 'N₂O Sensor 2a' signals via Modbus and Profibus data connections.

Please contact Unisense Environment for further guidance.

14.6. APPENDIX 6: CONNECTION CHART

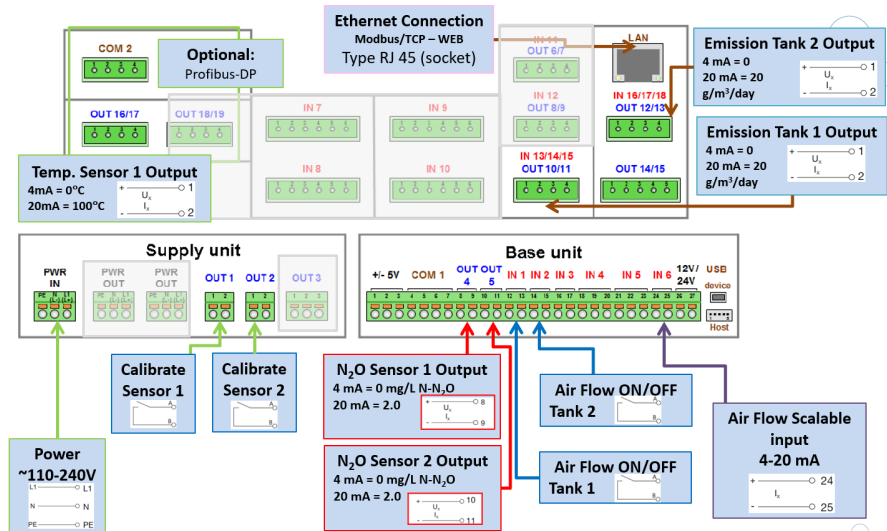

14.7. APPENDIX 7: INSTALLING AND EXCHANGING THE N₂O WASTEWATER SENSOR HEAD



N₂O Wastewater Sensor Head replacement



1

Follow these steps when the N₂O Sensor Head needs to be replaced. Start with step 3 for a first-time installation. **Handle the new N₂O sensor head with care as any impact can damage the sensor head!** Clean the sensor before proceeding!

Together with the N₂O sensor head replacement you will find a small pack of lubricant for the O-rings on the sensor and housing. You also need the plastic tube you received with the system to change the N₂O sensor head.

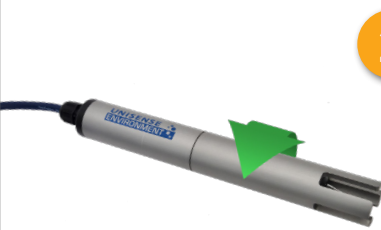

2



3

Unscrew the sensor body by holding on to the top (with the logo) and turn bottom part counterclockwise. Be careful when separating the two parts.

Use the plastic tube to push the old sensor head out of the sensor body. Next, apply grease to the two O-rings (one on the replacement sensor and one on the housing). You can now proceed to insert the new sensor in the housing!



4



5

After inserting the new N₂O sensor head, assemble the sensor and connect it to the control box. When the sensor is connected to the control box let it stabilize overnight before proceeding with the calibration procedure.

For the final part of the installation proceed with the N₂O Wastewater Sensor calibration manual!

14.8. APPENDIX 8: FORMULAS FOR CALCULATING EMISSIONS

N₂O Mass Transfer Coefficient Calculation from Aeration Field Size and Air Flow

In the aerated reactor the size of the total aeration field (m²) and the total air flow Q_A (NOTE the unit! m³s) for the aerated reactor is known. The total aeration field (m²) is measured as the reactor surface where leaving air bubbles are detected visually by on-site inspection.

The superficial gas velocity of the aerated reactor is calculated by dividing the total air flow with the aeration field size:

$$v_{g, 20^{\circ}\text{C}} \cong \frac{Q_{A, 20^{\circ}\text{C}}}{\text{Aeration field size}} \quad (1.1)$$

From the superficial gas velocity of the aerated reactor the N₂O mass transfer coefficient k_La_{N₂O} can be calculated using the empirical formula 3.2 based on laboratory experiments at 20°C in mixed WWTP liquor¹:

$$k_L a_{N_2O, 20^{\circ}\text{C}} = \left\{ \frac{D_R}{D_L} \right\}^{-0.49} \times 34500 \times (v_{g, 20^{\circ}\text{C}})^{0.86} \quad (1.2)$$

$$k_L a_{N_2O, 20^{\circ}\text{C}} = \left\{ \frac{D_R}{0.815 \text{ m}} \right\}^{-0.49} \times 34500 \times (v_{g, 20^{\circ}\text{C}})^{0.86} \quad (1.3)$$

v_g: Superficial gas velocity of the reactor (m³m⁻²s⁻¹) **D_L**: Depth of the laboratory reactor (0.815 m)
D_R: Depth over the diffuser of the reactor (m) **k_La_{N₂O}**: N₂O mass transfer coefficient (d⁻¹)

Finally the k_La_{N₂O} calculated above is temperature corrected to the process temperature T_{process}:

$$k_L a_{N_2O, T_{\text{process}}} = k_L a_{N_2O, 20^{\circ}\text{C}} \times (1.024)^{(T_{\text{process}} - 20^{\circ}\text{C})} \quad (1.4)$$

N₂O Emission Formula

The dissolved N₂O concentration and mixed liquor temperature are measured with the N₂O Wastewater System and values used to calculate the temperature compensated N₂O concentration in the aerated reactor (g-N/m³). From the input of the air flow Q_A in the aerated reactor the temperature compensated N₂O mass transfer coefficient k_La_{N₂O} is calculated using equations 1.1- 1.4.

With the values k_La_{N₂O} and Q_A known the N₂O emission rate per reactor volume can be calculated using the formula below^{ii,iii} (NOTE the Q_A unit! m³d⁻¹):

$$\text{Aerated zones: } r_{N_2O, T_{\text{process}}} = H_{N_2O, T_{\text{process}}} \times S_{N_2O} \left[1 - e^{-\frac{k_L a_{N_2O}}{H_{N_2O, T_{\text{process}}} \cdot \frac{V_R}{Q_{A, T_{\text{process}}}}} \right] \times \frac{Q_{A, T_{\text{process}}}}{V_R} \quad (2)$$

$$\text{Non - aerated zones: } r_{N_2O, T_{\text{process}}} = k_L a_{N_2O, T_{\text{process}}}^{\text{Non-aerated}} \times \left[S_{N_2O} - \frac{C_{N_2O, \text{air}}}{H_{N_2O, T_{\text{process}}}} \right] \quad (3)$$

r_{N₂O, T_{process}}: N₂O emission rate (g-N N₂O m⁻³d⁻¹)

H_{N₂O, T_{process}}: Henrys constant (dimensionless)

S_{N₂O}: N₂O concentration (g-N N₂O m⁻³)

Q_{A, T_{process}}: Total air flow through reactor per day (m³d⁻¹)

V_R: Volume of aerated part of reactor (m³)

k_La_{N₂O}: N₂O mass transfer coefficient (d⁻¹)

C_{N₂O, air}: N₂O concentration in air equilibrium (g-N/m³)

The dimensionless Henrys constant $H_{N_2O, T_{process}}$ is like the N_2O Wastewater sensor signal dependent on the process temperature and the temperature correction is calculated using equations 4.1- 4.2.

$$H_{N_2O, T_{process}} = \frac{1}{k_H \cdot R \cdot (T_{process} + 273.15) \cdot 10^3 \frac{L}{m^3}} \quad (4.1)$$

$$k_H = k_H^0 \times e^{\left(\frac{-\Delta solnH}{R} \left(\frac{1}{T_{process} + 273.15} - \frac{1}{T^0 + 273.15} \right) \right)} \quad (4.2)$$

k_H^0 : Henrys constant at the std. temp. ($mol \cdot L^{-1} \cdot bar^{-1}$) $T_{process}$: Mixed liquor temperature ($^{\circ}C$)

T^0 : Standard temperature = $25^{\circ}C$

$-\Delta solnH/R$: The enthalpy of the solution (K)

From literature the N_2O mean values for k_H^0 , $-\Delta solnH/R$ and supporting constant numbers are given in the below table:

k_H^0 ($mol \cdot L^{-1} \cdot bar^{-1}$)	$\frac{-\Delta solnH}{R}$ (K)	$C_{N_2O, air}$ ($g \cdot N/m^3$)	R ($m^3 \cdot bar \cdot mol^{-1} \cdot K^{-1}$)	$k_L a_{N_2O}^{Non-aerated}$ (d^{-1})
0.0247	2675	0.0003	8.314×10^{-5}	2 – 4

ⁱ Foley, J., de Haas, D., Yuan, Z., Lant, P. (2010) Nitrous oxide generation in full-scale biological nutrient removal wastewater treatment, plants. *Water Res.* 44, 831-844.

ⁱⁱ Schulthess, R. & Gujer W. (1996) Release of nitrous oxide (N_2O) from denitrifying activated sludge: Verification and application of a mathematical model, *Water Res.* 30, 521-530.

Validation papers:

ⁱⁱⁱ Baresel, C., Andersson, S., Yang, J., Andersen, M.H. (2016) Comparison of nitrous oxide (N_2O) emissions calculations at a Swedish wastewater treatment plant based on water concentrations versus off-gas concentrations, *Advances in Climate Change Research*, 7(3), 185-191.

^{iv} Janis E. Baeten, Mark C.M. van Loosdrecht, Eveline I.P. Volcke (2020) When and why do gradients of the gas phase composition and pressure affect liquid-gas transfer? *Water Res.* 178, 115844

14.9. APPENDIX 9:

**IMPORTANT – MAKE CHANGES
TO AVOID DATA LOSS**



Changing the Analogue Signal Range

When switching from a normal range sensor to a medium or high range sensor, the signal range must be adjusted. The N₂O Wastewater Controller has two analog channels with a default range from 0 to 2.0 mg N₂O-N/L. When using Medium or High range sensor heads, the channels should be rescaled to e.g. 0 to 10.0 mg N₂O-N/L.

It is a 2-step process where the output range as well as the logging range need to be changed separately.

IMPORTANT:

- Make sure the same scaling is used in the receiving data handling system.
- If a firmware update is performed, the controller will go back to default settings and this step must be repeated.



Step-by-step guide to output range rescaling:

1. Enter the menu system in the lower left corner and login as 'MASTER' with pin code '9200'.
2. Locate the submenu called 'Configuration' and enter this.
3. Locate the submenu called 'Analog outputs' and enter this.
4. Find the corresponding Analog output channel 1 or 2 for sensor 1 or sensor 2, respectively.
5. Find the value called 'Scale end 1' and tab the yellow window. An input window will popup.
6. Enter the new max scale range that 20 mA corresponds to 10 mg N₂O-N/L is used here.
7. Finally, press the 'OK' button and exit the menu.
8. **REMEMBER** to change the scaling in the SCADA system accordingly.

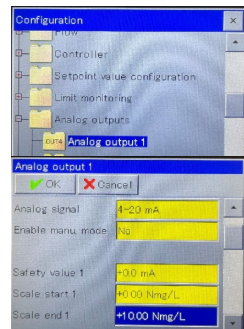

Step-by-step guide to logging range rescaling:

1. Enter the menu system in the lower left corner and login as 'MASTER' with pin code '9200'.
2. Locate the submenu called 'Configuration' and enter this.
3. Go to Formula 1 (and Formula 2 for sensor 2)
4. CHANGE the 'Display range end' from the default 2.0 to e.g. 10.0
 - a. 'Display range start' can be set to 0, or -1 if negative values should be visible

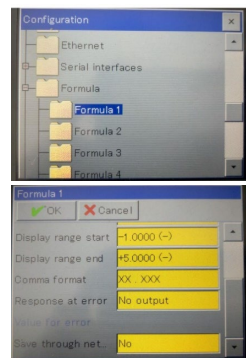

14.10. APPENDIX 10: ZERO CALIBRATION

Place the sensor in N₂O free water

- Take the sensor out of the wastewater and clean the outside if the sensor is dirty
- Place it in a bucket of tap-water, at the same temperature as the wastewater

Log in as "Operator" on the N₂O Wastewater Controller

- Follow the login procedure as described in the 2-point calibration manual.

Perform the zero calibration value on the N₂O Wastewater Controller

1. Press the button on the lower left hand side of the screen (the field showing date and time)
2. Press "Calibration"
3. Select the sensor you want to calibrate, then press "Zero-point calibration"
4. You will now see the signal in mg N₂O-N/L for this sensor. When this is stable press "OK"
5. Check that the value displayed in the blue field is "0.000" as shown. If this is not the case, press the blue field and enter the correct value.
6. Press "OK" to accept the new zero calibration value
7. Press "Yes" to apply the new calibration
8. Log out from the Wastewater Controller

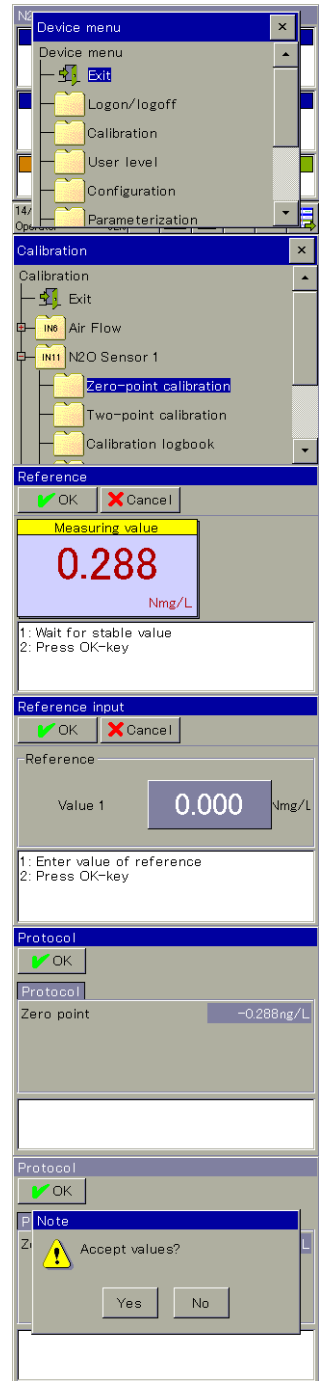

14.11. APPENDIX 11: USB DOWNLOAD OF DATA AND PCA3000 SOFTWARE

All the N₂O measurements and emission calculations are automatically saved in the N₂O Wastewater Controller. The memory in the Controller accommodates approximately 1 year of continuous data. Once you have reached the limit, the oldest data will be overwritten according to the first in first out principle. The stored data can be downloaded to a USB memory stick (USB 2.0) via the USB port on the controller.

Download data from the N₂O Wastewater Controller: Before the USB stick is plugged into the controller you must be logged in as 'Operator'. When the USB stick is plugged in, you can choose Recorder Update, which only downloads the data that has not been downloaded earlier. You can also choose Recorder backup, where all data currently stored in the N₂O Wastewater Controller is downloaded.

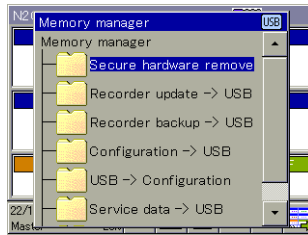

The screen display that appears when a USB stick is connected to the N₂O Wastewater Controller

PCA3000 Software

Measurements that are downloaded from the N₂O Wastewater Controller can be read on a computer using the PCA3000 software (ordered separately). In the following, there will be a short description of the most important functionalities of the PCA3000 software. Further information can be found in the PCA3000 software manual in the "Info" section in the software program's menu.

Installation of PCA3000 software: If you have bought the PCA3000 software you can install it using the installation file. Always make sure to have the latest version of the software installed on your computer. You can always find the latest version at www.jumo.net.

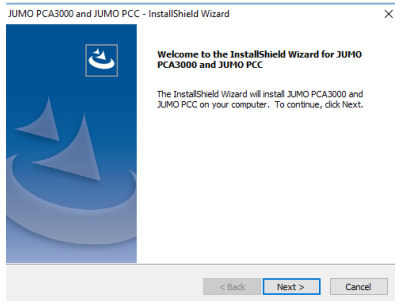

Insert your license number, after which the program can be opened. Alternatively, you can use the free 30-days trial version.

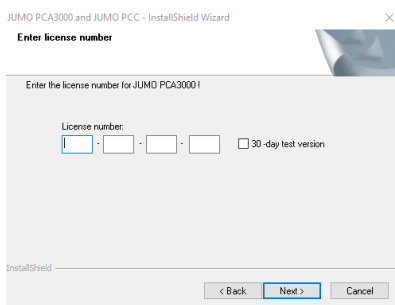

Transfer data to the PCA3000 software: Open the PCA3000 and choose Archive\Read in data. Choose which data on the USB stick you want to transfer and where you want to save them on the computer.

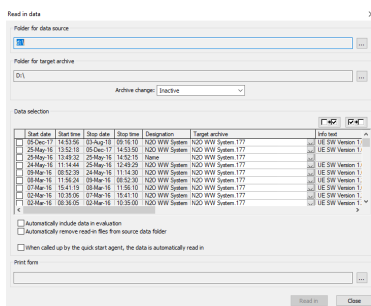

Open a data file: A PCA3000 file is opened under Archive. When the file is opened you can choose to open either the nitrous oxide concentration measurements or the emission rate data. It is not possible to open both at the same time.

All the measurements are shown on a graph and in a table under Analog. It is possible to zoom in and out on the graph using the zoom icons.

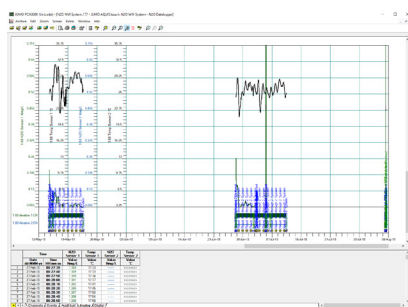
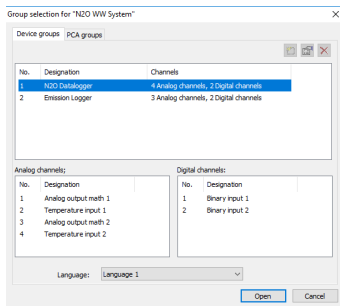

Export of data to a text file: Data stored in the PCA3000 software can be exported to a .txt file for further processing e.g. Excel. Open the file with the data you wish to export to a .txt file. The nitrous oxide concentrations and nitrous oxide emission data can be downloaded to separate .txt files. Go to 'Analog' and mark the measurements that you want to export (date and time are automatically exported with the marked data), right-click and chose to export the data to a .txt file.

Time	Date	Time	N2O Sensor 1		N2O Sensor 2		Temp Sensor 2	
			Value	Value	Value	Value	Value	Value
1	27-Feb-10	08:27:39	1389	1731	1731	1731	1731	1731
2	27-Feb-10	08:27:40	1389	1732	1732	1732	1732	1732
3	27-Feb-10	08:27:50	1389	1734	1734	1734	1734	1734
4	27-Feb-10	08:28:00	1391	1737	1737	1737	1737	1737
5	27-Feb-10	08:28:10	1393	1741	1741	1741	1741	1741
6	27-Feb-10	08:28:20	1395	1745	1745	1745	1745	1745
7	27-Feb-10	08:28:30	1397	1750	1750	1750	1750	1750
8	27-Feb-10	08:28:40	1399	1754	1754	1754	1754	1754
9	27-Feb-10	08:28:50	1399	1759	1759	1759	1759	1759
10	27-Feb-10	08:29:00	1395	1756	1756	1756	1756	1756
11	27-Feb-10	08:29:10	1391	1756	1756	1756	1756	1756
12	27-Feb-10	08:29:20	1389	1756	1756	1756	1756	1756
13	27-Feb-10	08:29:30	1391	1754	1754	1754	1754	1754
14	27-Feb-10	08:29:40	1390	1777	1777	1777	1777	1777
15	27-Feb-10	08:29:50	1407	1796	1796	1796	1796	1796
16	27-Feb-10	08:30:00	1412	1784	1784	1784	1784	1784
17	27-Feb-10	08:30:10	1416	1808	1808	1808	1808	1808
18	27-Feb-10	08:30:20	1416	1791	1791	1791	1791	1791
19	27-Feb-10	08:30:30	1417	1793	1793	1793	1793	1793
20	27-Feb-10	08:30:40	1418	1796	1796	1796	1796	1796
21	27-Feb-10	08:30:50	1420	1799	1799	1799	1799	1799
22	27-Feb-10	08:31:00	1421	1808	1808	1808	1808	1808
23	27-Feb-10	08:31:10	1423	1806	1806	1806	1806	1806
24	27-Feb-10	08:31:20	1424	1808	1808	1808	1808	1808
25	27-Feb-10	08:31:30	1426	1811	1811	1811	1811	1811
26	27-Feb-10	08:31:40	1426	1813	1813	1813	1813	1813
27	27-Feb-10	08:31:50	1427	1816	1816	1816	1816	1816
28	27-Feb-10	08:32:00	1429	1818	1818	1818	1818	1818
29	27-Feb-10	08:32:10	1430	1820	1820	1820	1820	1820
30	27-Feb-10	08:32:20	1431	1822	1822	1822	1822	1822
31	27-Feb-10	08:32:30	1432	1825	1825	1825	1825	1825
32	27-Feb-10	08:32:40	1433	1827	1827	1827	1827	1827
33	27-Feb-10	08:32:50	1434	1829	1829	1829	1829	1829
34	27-Feb-10	08:33:00	1435	1832	1832	1832	1832	1832
35	27-Feb-10	08:33:10	1436	1834	1834	1834	1834	1834

If you start by opening the nitrous oxide concentrations the nitrous oxide emission data can be opened by clicking Archive\Open further group... Choose Emission Logger.

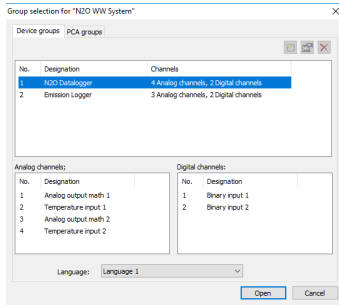

The nitrous oxide emission rates are in the Analog window. Mark the measurements that need exporting (Date and time are automatically exported with the marked data), right-click on the mouse and chose export data to .txt file.

	Time		Emission Rate 1	Emission Rate 2	Air Flow
	Date dd-MMM-yy	Time HH:mm:ss	Value Rate	Value Rate	Value m3/h
1	27-Feb-18	08:27:39	14.9500	-----	786
2	27-Feb-18	08:28:00	14.9500	-----	778
3	27-Feb-18	08:28:30	15.0000	-----	772
4	27-Feb-18	08:29:00	15.0833	-----	771
5	27-Feb-18	08:29:30	15.0500	-----	774
6	27-Feb-18	08:30:00	15.2500	-----	772
7	27-Feb-18	08:30:30	15.3833	-----	770
8	27-Feb-18	08:31:00	15.4667	-----	769
9	27-Feb-18	08:31:30	15.5333	-----	768

Navigation: Channels / Events / Audit trail / **Analog** / Digital

Further information on the PCA3000 software: The complete manual describing the PCA3000 software can be found in the program in Info\ Software documentation.

14.12. APPENDIX 12: MODBUS/TCP CONNECTION AND SETUP GUIDE (FIRMWARE 2.2)



Version Firmware 2.3 – May 2024

Modbus/TCP Connection and Setup Guide

Cable and connection: (p35-36, 41)

A patch/crossover cable with an RJ45 connector is required to use the Ethernet interface.

- The Ethernet interface can be configured directly on the device.
- DHCP and DNS are also supported. It is possible to obtain the IP configuration automatically via DHCP. If necessary, the IP configuration can also be set up manually.
- In the N₂O Wastewater System, the **TCP port 502** is set permanently to Modbus/TCP and cannot be changed.
- Bus users are identified by their IP address. The **Unit ID** (Modbus device address in the Modbus/TCP telegram) is set permanently to **255** (See “Modbus/TCP” on page 41.)

Address table:

N₂O concentration and emission

Hex	Dec	Data type	Access	Data	Value Note
16BB	5819	float	r/o	Measured temperature value IN 4	Temperature value Sensor 1 (°C, degrees)
16BD	5821	float	r/o	Measured temperature value IN 5	Temperature value Sensor 2 (°C, degrees)
1BEE	7134	float	r/o	Calculated result formula 14*	N ₂ O Concentration value Sensor 1 (g/m ³ N-N ₂ O)
1BE2	7138	float	r/o	Calculated result formula 16*	N ₂ O Concentration value Sensor 2 (g/m ³ N-N ₂ O)
15C9	5577	float	r/o	Calculated result formula 3	N ₂ O Emission value Sensor 1 (g/m ³ /day N-N ₂ O)
15CB	5579	float	r/o	Calculated result formula 4	N ₂ O Emission value Sensor 2 (g/m ³ /day N-N ₂ O)

*Replaces old N₂O concentration value for Sensor 1 and 2

N₂O Sensor Info, alarm, and calibration information

Hex	Dec	Data type	Access	Data	Value Note
15A5	5541	uint32	r/o	Remaining time to calibration N ₂ O Sensor 1	Time in seconds
15A7	5543	uint32	r/o	Remaining time to calibration N ₂ O Sensor 2	Time in seconds
1746	5958	bool	r/o	Recalibrate Sensor 1 (Relay)	Do a new Calibration Sensor1
1747	5959	bool	r/o	Recalibrate Sensor 2 (Relay)	Do a new Calibration Sensor2
14BB	5307	bool	r/o	AutoZero Sensor1	True if AutoZero running
14C3	5315	bool	r/o	ZeroCalibrate Sensor1	Do a new Zero Calibration Sensor1
14BC	5308	bool	r/o	AutoZero Sensor2	True if AutoZero running
14C4	5316	bool	r/o	ZeroCalibrate Sensor2	Do a new Zero Calibration Sensor1
14BD	5309	bool	r/o	MaxTempRange Sensor 1	Process Temp. >±3°C from Cal. Temp.
14C5	5317	bool	r/o	Recalibrate Sensor 1	Process Temp. >±4°C from Cal. Temp.

14BE	5310	bool	r/o	MaxTempRange Sensor 2	Process Temp. >±3°C from Cal. Temp.
14C6	5318	bool	r/o	Recalibrate Sensor 2	Process Temp. >±4°C from Cal. Temp.

Raw values (optional)

Hex	Dec	Data type	Access	Data	Value Note
15C5	5573	float	r/o	Calculated result formula 1 No AutoZero	N ₂ O Concentration value Sensor 1 (g/m ³ N-N ₂ O)
15C7	5575	float	r/o	Calculated result formula 2 No AutoZero	N ₂ O Concentration value Sensor 2 (g/m ³ N-N ₂ O)
16A0	5792	float	r/o	Measured value IN 6 compensated2	Airflow input (m3/h)
16A2	5794	float	r/o	Measured value IN 11 compensated	N ₂ O raw value Sensor 1
16A4	5796	float	r/o	Measured value IN 12 compensated	N ₂ O raw value Sensor 2
16BB	5819	float	r/o	Measured temperature value IN 4	Temperature value Sensor 1
16BD	5821	float	r/o	Measured temperature value IN 5	Temperature value Sensor 2
16DA	5850	bool	r/o	Binary value IN 1	Air ON tank 1
16DB	5851	bool	r/o	Binary value IN 2	Air ON tank 2



www.unisense-environment.com · sales@unisense.com